

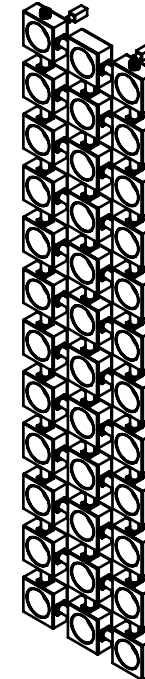

## VD 0312 Mural

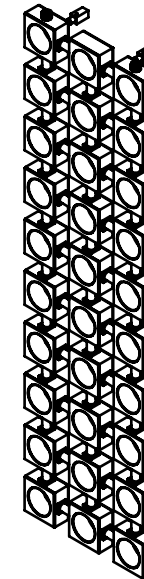
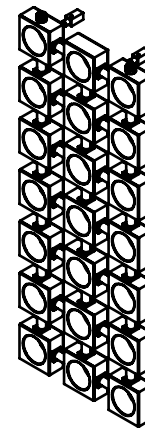
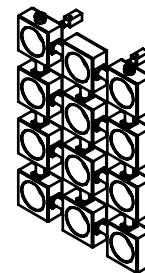
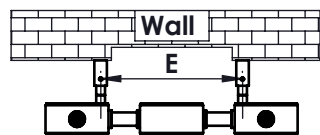
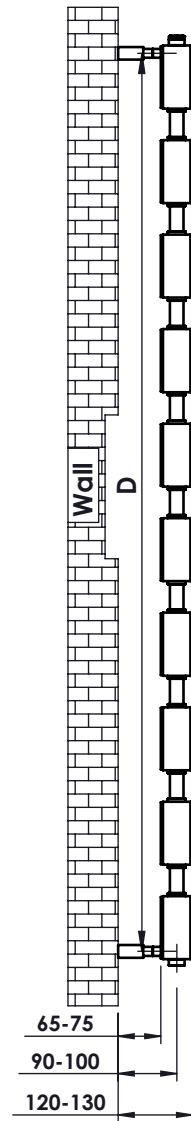
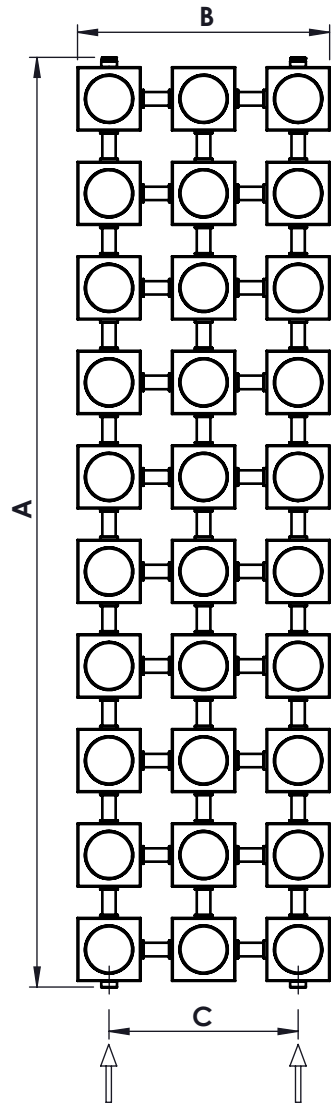

| A<br>HEIGHT<br>mm | B<br>LENGTH<br>mm | C<br>PIPE CENTER<br>mm | D<br>VERTICAL<br>BRACKET<br>CENTERS<br>mm | E<br>HORIZONTAL<br>BRACKET<br>CENTERS<br>mm | HEAT<br>OUTPUTS<br>(BTU)<br>Delta T:50°C | HEAT<br>OUTPUTS<br>(WATT)<br>Delta T:50°C |
|-------------------|-------------------|------------------------|---|---|--|---|
| 576               | 400               | 300                    | 525                                       | 225   | 2172                                     | 636                                       |
| 1020              | 400               | 300                    | 975                                       | 225   | 3802                                     | 1113                                      |
| 1476              | 400               | 300                    | 1425                                      | 225   | 5431                                     | 1590                                      |
| 1770              | 400               | 300                    | 1725                                      | 225   | 5779                                     | 1692                                      |
| 2220              | 400               | 300                    | 2175                                      | 225   | 8146                                     | 2385                                      |

Bracket Assembly

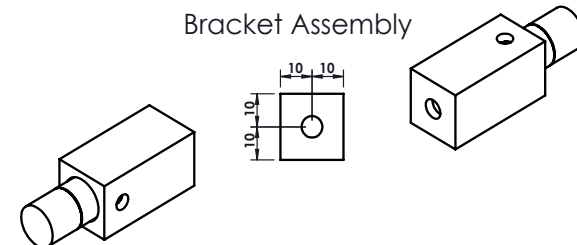

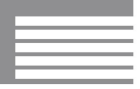

## VD 0312 Sol - Plafond

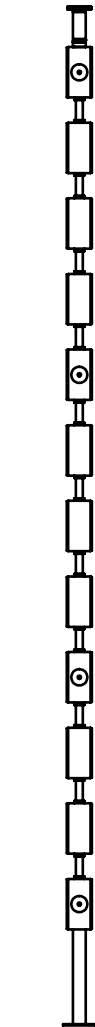
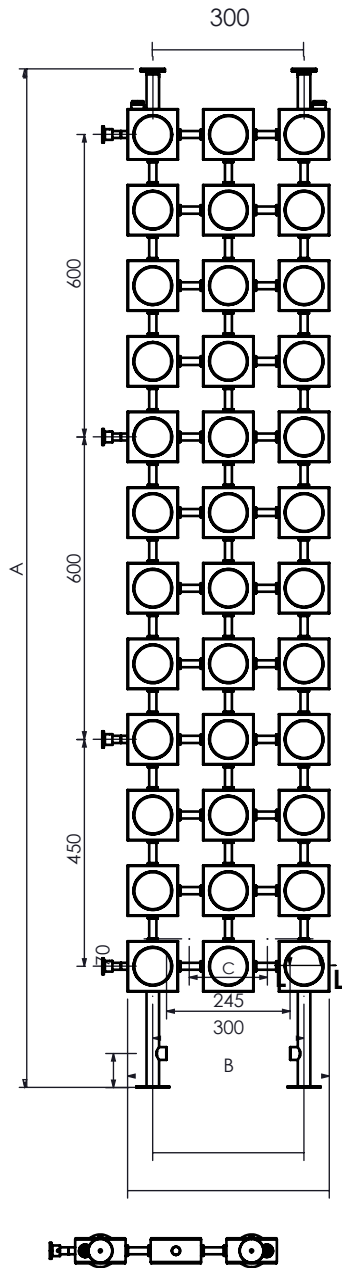

L-L (1 : 10)

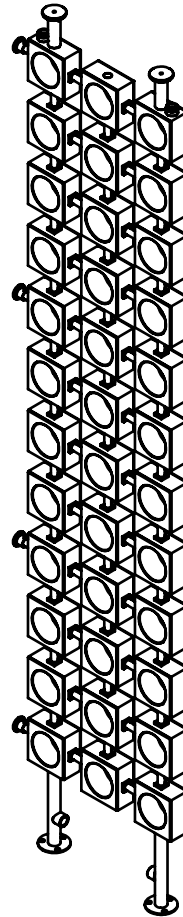

| A         | B      | C           | D                        | E                          | HEAT OUTPUTS (BTU) | HEAT OUTPUTS (WATT) |
|-----------|--------|-------------|--------------------------|----------------------------|--------------------|---------------------|
| HEIGHT    | LENGTH | PIPE CENTER | VERTICAL BRACKET CENTERS | HORIZONTAL BRACKET CENTERS | Delta T:50 °C      | Delta T:50 °C       |
| mm        | mm     | mm          | mm                       | mm                         |                    |                     |
| 1740-1790 | 400    | 155         | -                        | -                          | 5431               | 1590                |
| 2020-2070 | 400    | 155         | -                        | -                          | 5779               | 1692                |
| 2490-2540 | 400    | 155         | -                        | -                          | 8146               | 2385                |

Wall Bracket Assembly

